

NIVONA

passion for coffee

GB User manual



WELCOME TO THE NIVONA FAMILY!

We are delighted at the confidence you have shown in us by choosing a quality product from NIVONA.

We would like to express our sincere **THANKS**.

To ensure maximum enjoyment of your NIVONA machine, please read through this document carefully and pay attention to the safety instructions before using the machine for the first time.

Please keep this document in a safe place. Then you can use it as a reference or pass it on to any subsequent owner.

We hope you enjoy your NIVONA product and, with it, a good, flavourful cup of coffee.

Best wishes to you from the NIVONA team!



SYMBOLS USED

The following symbols are used in these instructions:



CAUTION

This symbol draws your attention to possible dangers.



NOTE

This symbol draws your attention to special information.



CAUTION

Hot surface

TABLE OF CONTENTS

1. SAFETY INFORMATION	4	7. BASIC SETTINGS	15
1.1. Correct use	4	7.1. General settings	15
1.2. General instructions for the user.....	4	7.2. Set grind fineness	16
1.3. Limits to the range of users	5	8. CLEANING & MAINTENANCE	17
2. CONTROL ELEMENTS	6	8.1. Rinse frother	18
3. OPERATION OF THE MACHINE	7	8.2. Clean frother.....	19
3.1. Operation with the rotary dial.....	7	8.3. Rinse system	19
3.2. Operation of the valve	8	8.4. Clean system	20
3.3. Symbol functions	8	8.5. Descale system.....	21
4. INITIAL STARTUP	9	8.6. Remove & clean brewing unit.....	22
4.1. Preparation	9	8.7. Clean regularly by hand.....	22
4.2. Initial Start menu.....	9	8.8. Disassemble and clean frother.....	23
5. MENU NAVIGATION	11	8.9. Change filter	24
6. PREPARE SPECIALITY COFFEES	12	8.10. Status of maintenance	24
6.1. Draw speciality coffee.....	12	9. SOLVING PROBLEMS YOURSELF	25
6.2. Recipe menu	13	10. ACCESSORIES & COFFEE ASSORTMENT	28
6.3. 2-cup function.....	13	11. CUSTOMER SERVICE & WARRANTY	28
6.4. Prepare ground coffee.....	14	12. PACKAGING & DISPOSAL	28
		13. TECHNICAL DATA	29

1. SAFETY INSTRUCTIONS

CAUTION

Repairs to electrical appliances must be carried out only by specialised technicians! Improper repairs can expose the user to considerable dangers! If the machine is used other than for its intended purpose or is operated or maintained improperly, we cannot accept liability for any resulting damage!

CAUTION

Actuating the on/off switch during the brewing process can damage the machine! Switch the machine off only when it is idle!

CAUTION

Danger of burns! Hot water might spray out of the Spumatore at first when steam / milk froth or hot water is drawn: touch the outlet or Spumatore only when cold.

1.1. Correct use

- The machine may only be used for its designated purpose (use only in private households) and is not intended for commercial use, which would void the warranty (see accompanying warranty terms).

1.2. General instructions for the user

- Set the machine on a dry, level and stable surface, and use it only indoors. Never place this machine on a hot surface, near other appliances which become very hot when in use (e.g. stove, deep fryer), or near open flames.
- The machine must not be used in cupboards or other closed pieces of furniture.
- The mains supply voltage must always match the working voltage of the machine. Please refer to the type plate on the machine.
- The machine must not be used at altitudes over 2000 m above sea level.
- Do not operate the machine if the mains supply cable or the casing is damaged. Never let the mains supply cable touch hot parts.
- If the mains supply cable of the machine is damaged, it must be replaced by the manufacturer, its customer service representative, or a similarly qualified technician to avoid hazards.
- Never immerse the machine in water.
- Always keep the mains supply plug dry and keep it away from moisture.
- Do not pull on the mains supply cable to disconnect the plug from the mains socket.

- If a fault occurs, disconnect the mains plug immediately (never by pulling on the mains supply cable or the machine itself).
- Before carrying out maintenance or cleaning, check that the machine is switched off and that the mains plug is disconnected.
- No liability for damage is accepted in case of incorrect operation, improper use, or incorrect repairs. The warranty is void in these cases.
- Always follow the instructions for cleaning and descaling! Failure to comply voids the warranty.
- Never clean the machine or individual parts in the dishwasher. Failure to comply voids the warranty.
- Do not leave the machine switched on unnecessarily.
- If you will be away for several days, always unplug the mains cable.
- Please use the integrated coffee grinder only to grind roasted and untreated coffee beans, not for other food items! Always make sure that there are no foreign objects mixed in with the coffee beans, which voids the warranty.

- If repair of the machine is required (including replacement of the mains cable!), please first contact the NIVONA service telephone or the dealer from which the machine was purchased, and, after consultation with us and observing the section “How to make your machine ready for shipment” in Chapter 11 of this document, send it to **NIVONA Central Customer Service, Südwestpark 49, D-90449 Nuremberg, Germany.**

1.3. Limits to the range of users

- This machine can be used by children 8 and older and by persons with physical, sensory, or mental impairments or who are lacking in experience and knowledge, provided they are acting under supervision or have been instructed on how to use the machine safely and are aware of the possible dangers. Children must not play with the machine. Cleaning and maintenance of this machine must not be carried out by children unless they are age 8 or over and are acting under supervision. The machine and its connection line must be kept away from children younger than 8.

2.

2. CONTROL ELEMENTS

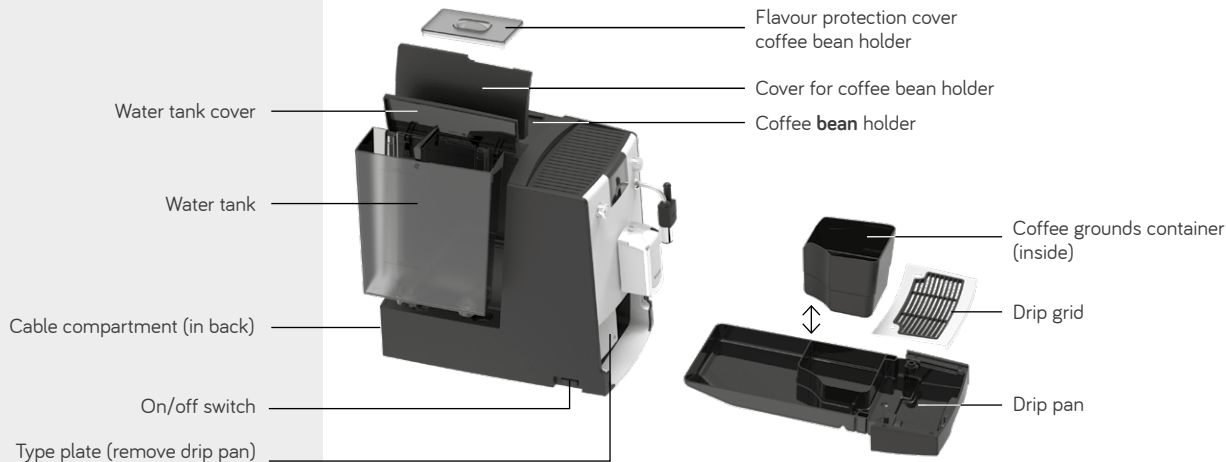

WELCOME PACK

(included with machine)

- User manual
- Warranty terms
- Measuring spoon
- 2 cleaning tablets
- Test strips (for measuring water hardness)
- Connection tube for milk

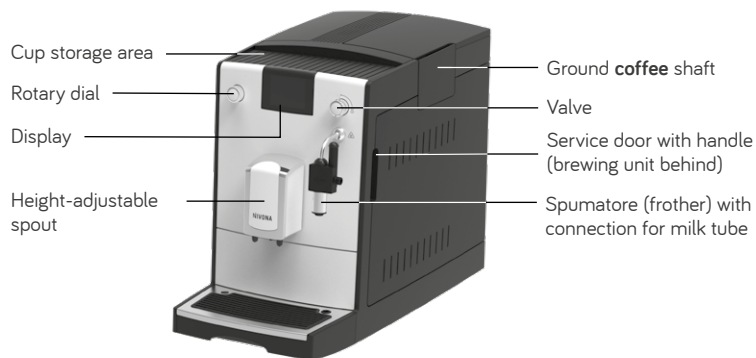

3. OPERATION OF THE MACHINE

The NIVONA machine can be operated using the *rotary dial* and the valve:

3.1. Operation with the rotary dial



Rotary dial

navigate / select / change / confirm by turning and pressing

Turning

To switch between the **SPECIALITY COFFEES** and the main menus **SETTINGS** and **MAINTENANCE**, to select / navigate within the main menus and to change the setting options in the submenus and **recipe menu**.

Short press

To start / confirm the currently marked function.

In the submenus and in the **recipe menu**, the first press selects the setting parameters and the next press confirms the change.

A short press when the beverage is drawn cancels the procedure.

Long press

In the **SPECIALITY COFFEES**, a long press takes you to the recipe menu where you can change the settings. A long press in the recipe menu will return you to the main menu.



Turning



Pressing

Open /
close valve

Valve closed



Valve opened

3.2. Operation of the valve

The valve opens or closes the Spumatore (frother) when hot water or milk froth is drawn.

3.3. Symbol functions

	Location / process progress		Cancellation of a beverage draw
	One step back		START a SPECIALITY COFFEE beverage draw
	Message / instruction for action		Save changes

The currently selected symbol / function is optically marked; for the **SPECIALITY COFFEES** the symbol description is displayed

Even **during** a coffee draw that has already started, various parameters can be changed by turning the *rotary dial* **as long as they are optically marked**.

A beverage can be cancelled by pressing the *rotary dial* once while the beverage is being dispensed. If the draw is cancelled while the parameters are still optically marked, the *rotary dial* must be pressed twice.

4. INITIAL STARTUP

4.1. Preparation

- Remove the machine and other supplied parts from the packaging
- Place the machine on a level, dry work surface (ventilation slots must not be covered)
- Connect the mains supply cable to a power socket which has been correctly installed (any unnecessary length of cable remains inside the cable compartment)
- Connect the milk tube to the Spumatore and drip pan
- Turn on machine

When the machine is switched on **after the initial startup**, it first heats up, the display shows **SYSTEM RINSING** and the rinsing process starts automatically.

4.2. Initial Start menu

The instructions on the display lead you through the Initial Start menu conveniently and step-by-step.

Set language

- Select the language with the *rotary dial* and confirm

Set filter

- Select filter setting with the *rotary dial*



Milk tube – attached /
connected to the Spumatore

i NOTE

Details on **Operation of the Machine** are contained in Chapter 3, starting at page 7.

i NOTE

If used with a filter, the machine does not need to be descaled as often.

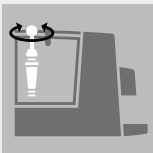

Screw filter into water tank

Test strips	Degree of hardness	Water hardness display
≤ 1 red point	1 - 7°	WATER HARDNESS 1
2 red points	8 - 14°	WATER HARDNESS 2
3 red points	15 - 21°	WATER HARDNESS 3 (factory settings)
≥ 4 red points	> 21°	WATER HARDNESS 4



FILL WATER TANK



FILL COFFEE BEANS

i NOTE

At initial startup, the grinding chamber is still empty. After the first grinding, it is possible that **FILL COFFEE BEANS** is displayed and the machine does not make coffee.

➤ Press the *rotary dial* again for an additional draw; the process is then repeated

Operation with filter

- Set the menu setting to **FILTER "YES"** and confirm with the *rotary dial*.
- Using the mounting aid at the end of the measuring spoon, screw the filter into the water tank and confirm using the *rotary dial*.

Operation without filter (factory settings)

- Set the menu to **FILTER "NO"** and confirm with the *rotary dial*

When using the machine without a filter, the water hardness must be entered in the next step.

Set water hardness*

- Immerse supplied test strip briefly in water, shake it off and read the test result after about 1 minute
- In the menu, use the *rotary dial* to select the water hardness read from the test strip and confirm

Fill water tank (> 0.5l)

- **Remove** the water tank, fill water tank with fresh, cold water without carbonation (no mineral water) and reinsert the tank
- Do not fill with any carbonated liquids or any other liquids, or the warranty is void!

Fill coffee bean holder

- Fill the coffee bean holder with untreated, roasted coffee beans without foreign objects or dirt and without sugar, then close the aroma protection cover well and confirm using the *rotary dial*

* for operation without filter

Fill / rinse system, rinse filter

- Place a large container (> 0.5 l) under the Spumatore and confirm with the *rotary dial*
- Open the valve and wait until no more water comes out of the Spumatore, then close the valve and empty the container.
- Place a large container (\geq 0.5 l) under the height-adjustable outlet and confirm with the rotary dial
- Wait until no more water comes out of the outlet, then empty the container

Operation tutorial

At the end of the initial startup, a short tutorial on the machine's operation appears. All operating functions that should be performed when they appear are shown on the display one after another. As soon as an operating function has been performed, the next one appears. If an operating function is not carried out, the next one appears automatically after some time.

All settings that were determined during initial startup can be changed at any time in the **SETTINGS** menu.

5. MENU NAVIGATION

In the NIVONA machine there is a choice of **SPECIALITY COFFEES** and the main menus **SETTINGS** and **MAINTENANCE**. All available functions of the machine can be carried out there.

Detailed information on navigation within and between the main menus is found in Chapter 3 starting at page 7.



FILTER RINSING

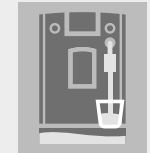

SYSTEM FILLING

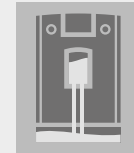

SYSTEM RINSING



SETTINGS



MAINTENANCE

6.



Connect milk source

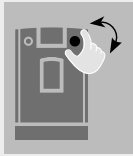

Open / close valve

CAUTION

Danger of burns! The escaping water may splash! The Spumatore (frother) becomes very hot during use. Let the Spumatore cool down for a few minutes before touching it. Only touch the Spumatore by the rubber parts.



RINSE FROTHER

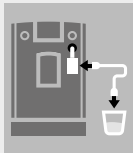

CONNECT TUBE TO FROTHER AND PUT IN WATER



FROTHER RINSING

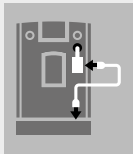

CONNECT TUBE TO FROTHER AND PUT IN DRIP GRID

6. PREPARE SPECIALITY COFFEES

6.1. Draw speciality coffee

- Select the desired **SPECIALITY COFFEE**
- For speciality coffees with milk,* connect the milk-filled container (milk container, milk refrigerator, Tetra Pack, or similar) to the lower end of the milk tube. The upper end remains in the Spumatore
- A short press on the desired speciality coffee begins the beverage draw
- After completion of the draw of a speciality coffee with milk, the display shows the message / instruction to rinse the Spumatore (frother). The Spumatore should then be rinsed as soon as possible, but at the latest before switching off the machine. To do this, insert the tube into a container of clean water, then select and confirm the message / instruction on the display by turning the *rotary dial*. Follow the instructions in the display up to the end of the program and confirm each time with the *rotary dial*.

CAUTION

When milk froth is being drawn, water comes out first, then milk froth.

CAUTION

Dried milk residue on the Spumatore (frother) is hard to remove. Clean everything as soon as it cools down.

* The beverage draws for coffee and milk froth must be started one after the other

6.2. Recipe menu

The recipe menu is a submenu in the individual speciality coffees. Here, the factory recipe settings can be changed individually and stored permanently.

- A long press on the *rotary dial* on the symbol of a speciality coffee leads to the **recipe menu** of the beverage

Adjustable parameters in the recipe menu:

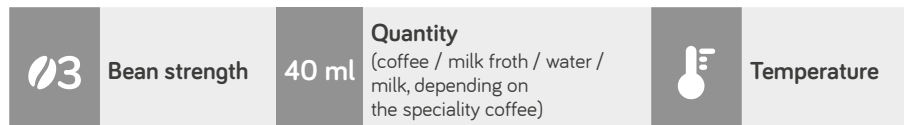

- A short press on the activated **Save** symbol saves the beverage recipe with the changed parameters
- A short press on the activated **Start** symbol begins the beverage draw with the changed parameters

6.3. 2-cup function*

To fill two cups directly next to each other from the same beverage draw, a second cup must be placed under the outlet and then

- press the *rotary dial* briefly twice in succession to start beverage preparation (for the current draw)

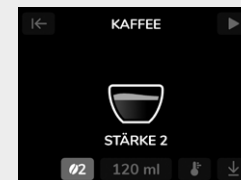

Recipe menu



SAVE
RECIPE



Start beverage
draw in the
recipe menu



1 CUP



2 CUPS

* only for ESPRESSO and COFFEE

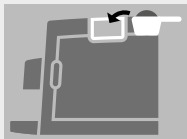
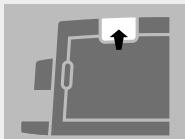
FILL GROUND
COFFEE

CLOSE SHAFT LID

 **CAUTION**

The ground coffee shaft is not a storage container. Therefore, never add more than one portion to the shaft and use only fresh or vacuum-packed ground coffee from coffee beans.

Water-soluble instant coffee must not be used!

 **NOTE**

If you accidentally open the ground coffee shaft – or have not started a beverage draw after adding ground coffee – the machine is automatically rinsed about one minute after the cover is closed again and is then ready for use again.

6.4. Prepare ground coffee

- Open the cover of the ground coffee shaft (underneath the cover on the upper right of the machine)
- The display shows **FILL GROUND COFFEE AND CLOSE SHAFT LID**
- Add a level measuring spoon of ground coffee
- Close cover and flap
- The display shows when the ground coffee is ready
- Place a cup in the middle below the coffee outlet
- Select the beverage in the **SPECIALITY COFFEES**
- Start preparation

7. BASIC SETTINGS

7.1. General settings

All of the following parameters can be changed, edited or checked in the **SETTINGS** menu using the *rotary dial*.



SETTINGS

<p>FILTER</p> <ul style="list-style-type: none"> - Set operation with / without filter 	<p>TIMES</p> <ul style="list-style-type: none"> - Set an automatic switch-off time 	<p>STATISTICS</p> <ul style="list-style-type: none"> - Displays the draws per speciality coffee and the performed maintenance functions since initial startup
<p>LANGUAGE</p> <ul style="list-style-type: none"> - Set the language 	<p>FACTORY SETTINGS</p> <ul style="list-style-type: none"> - Recipes and settings can be reset to the factory settings here 	<p>WATER HARDNESS</p> <ul style="list-style-type: none"> - Set the water hardness (only displayed during operation without filter)

If the *rotary dial* has not been actuated for a longer period of time, the machine switches automatically into the **ECO mode**. A screensaver appears on the display. Actuate the *rotary dial* to leave the **ECO mode**.

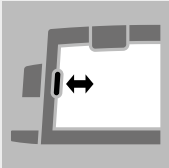

Open / close
service door

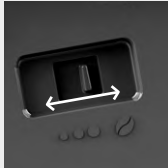

Set grind fineness

CAUTION

The grind fineness may only be set when the grinder is running!

The grinder can be adjusted to adapt to the roast of the coffee beans. We recommend you always leave the grinder at a medium setting.

NOTE

When changing the grind fineness, we recommend:

- a finer setting for light roasts (regulator further to the left),
- a coarser setting for dark roasts (regulator further to the right).

7.2. Set grind fineness

To change the grind fineness, please:

- Open the service door on the right side of the housing (gently pull the recess in the handle away from the housing, then carefully remove the service door from the housing)
- Place cup under the height-adjustable outlet
- Set *rotary dial* to the SPECIALITY COFFEE **ESPRESSO**, then press the *rotary dial*
- While the grinder grinds, change the grind fineness by moving the regulator (above right) (left = finer, right = coarser)
- Close service door again (guide pins at the rear end of the service door into the recesses, then press the service door until it locks in place)

8. CLEANING & MAINTENANCE

All cleaning and maintenance programs can generally be selected and started in the **MAINTENANCE** menu. If a message / instruction for a cleaning / maintenance activity appears on the display, this program can also be started directly through the message / instruction.

- Select and confirm the instruction with the *rotary dial* or
- Select **MAINTENANCE** menu
- Select the cleaning or maintenance program and start it with the *rotary dial*

The machine starts the corresponding cleaning or maintenance process and displays instructions for additional actions.

- Follow the instructions in the display up to the end of the program and confirm each time with the *rotary dial*



MAIN-
TENANCE



Message /
instruction

**CAUTION**

The running program must not be interrupted!

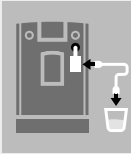

CONNECT TUBE TO FROTHER AND PUT IN WATER



FROTHER RINSING

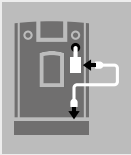

CONNECT TUBE TO FROTHER AND PUT IN DRIP GRID

8.1. Rinse frother

After you make speciality coffees with milk, the display instructs you to rinse the frother. This should be done as soon as possible, but at the latest before switching off the machine. Proceed as follows:

- Select and confirm the instruction with the *rotary dial*
- In the **MAINTENANCE** menu, select the menu option **RINSE FROTHER**
- Connect one end of the supplied tube to the Spumatore, insert the other end of the tube into a container of water and confirm with the *rotary dial*
- Place a sufficiently large container (≥ 0.5 l) under the Spumatore
- Open the valve and wait until no more water comes out of the Spumatore, then close the valve
- Connect the lower end of the tube to the drip grid
- Open the valve and wait until no more water comes out of the Spumatore, then close the valve and empty the container

As soon as the rinse cycle is ended, the machine heats up and is then ready for operation again.

8.2. Clean frother

- Select and confirm the message / instruction with the *rotary dial* or
- In the **MAINTENANCE** menu, select the menu option **CLEAN FROTHER**
- Put some detergent (recommendation: NIVONA CreamClean milk system cleaner) and water in a container (at least 0.3 l)
- Please observe the instructions of the detergent manufacturer for the mix ratio
- Follow the instructions in the display up to the end of the program and confirm each time with the *rotary dial*

The machine then heats up and is ready for operation again.

8.3. Rinse system

The system should be rinsed from time to time.

- In the **MAINTENANCE** menu, select the menu option **RINSE SYSTEM**. The display shows **SYSTEM RINSING**

As soon as the rinse cycle is ended, the machine heats up and is then ready for operation again.



CAUTION

The running program must not be interrupted!

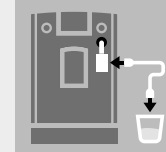

CONNECT TUBE
TO FROTHER
AND PUT IN
CLEANER



NOTE

A message / instruction is shown on the display when the frother has to be cleaned.



CAUTION

The running program must not be interrupted!

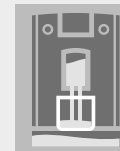

SYSTEM RINSING

⚠ CAUTION

The running program must not be interrupted!

Please do not insert a cleaning tablet into the round opening of the brewing unit until the machine instructs you to do this.

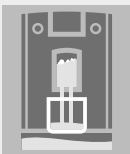

SYSTEM
CLEANING

i NOTE

A message / instruction is shown on the display when the machine has to be cleaned. Beverages can still be drawn. But we recommend carrying out the cleaning program as soon as possible to avoid endangering the warranty.

We recommend also cleaning the brewing unit BEFORE the system cleaning (see also Chapter **Remove & clean brewing unit** on page 22).

8.4. Clean system

- Select and confirm the instruction with the *rotary dial* or
- In the **MAINTENANCE** menu, select the menu option **CLEAN SYSTEM**
- Put a sufficiently large container (≥ 0.5 l) under the height-adjustable outlet
- Follow the instructions in the display up to the end of the program and confirm each time with the *rotary dial*

The machine then heats up and is ready for operation again.

8.5. Descal system

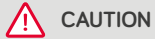

CAUTION

The running descaling program must not be interrupted!

Never use vinegar or vinegar-based products for descaling, but always use **liquid products** recommended for fully automatic coffee machines (recommendation: NIVONA PREMIUM liquid descaler).

The filter (if present) must be removed from the water tank prior to the start of the descaling program.

During descaling, please follow exactly the sequence of the displays!

First pour in the corresponding amount of **water** up to the 0.5 l mark and **then** add the **descaler**. **Never in reverse order!** Observe the instructions of the descaler manufacturer.

- Select and confirm the instruction with the *rotary dial* or
- In the **MAINTENANCE** menu, select the menu option **DESCALE SYSTEM**
- Place a sufficiently large container (≥ 0.5 l) under the Spumatore
- Follow the instructions in the display up to the end of the program and confirm each time with the *rotary dial*

The machine then heats up and is ready for operation again.



CAUTION

Please always remove residual descaling fluid on the housing with a moist cloth afterwards!



NOTE

A message / instruction is shown on the display when the machine has to be descaled. (The descaling program can also be started manually at any time.) Beverages can still be drawn. But we recommend carrying out the descaling program as soon as possible to avoid endangering the warranty.

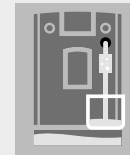

SYSTEM
DESCALING

**CAUTION**

Clean the brewing unit before every cleaning program, but at least once a month. Otherwise, the warranty can be void.

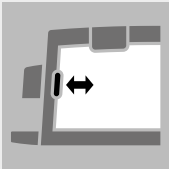

Open / close
service door



UNLOCK
BREWING UNIT

8.6. Remove & clean brewing unit

The brewing unit should be removed and cleaned under running water as needed and before each cleaning program. Please never use detergent, but only pure **cold** water!

- Open the service door on the right side of the housing (gently pull the recess in the handle away from the housing, then carefully remove the service door from the housing)
- Unlock brewing unit (press red switch upwards and turn the handle to the left up to the stop and to lock)
- Carefully remove the brewing unit with the handle
- Clean brewing unit under cold, running water and **then let it dry**
- Carefully insert brewing unit again and lock it (hold down red switch and turn the handle to the right up to the stop and to lock it)
- Close service door again (guide pins at the rear end of the service door into the recesses, then press the service door until it locks in place)

8.7. Clean regularly by hand

NOTE

Please follow these cleaning instructions. Maximum cleanliness is required, especially when handling food and beverages. Occasionally use some soapy water to clean the drip pan.

- Clean the housing inside and outside only with a soft, moist cloth without detergent
- Empty the drip pan and coffee grounds container not later than when shown in the display (only with the machine switched on, as only then can it tell that the containers have been emptied)
- After the drip pan and coffee grounds container have been removed, clean the housing inside with a soft, moist cloth without detergent
- The water tank should be rinsed with clean water daily and refilled with fresh, cool water
- Clean the Spumatore (frother), tube and outlet regularly

8.8. Disassemble and clean frother

- Pull the Spumatore (frother) downwards slightly to remove it and disassemble it into its individual parts
- Thoroughly clean the parts and put the Spumatore (frother) back together
- Reinsert the assembled Spumatore (frother)

CAUTION

Never immerse the machine in water!

Do not use scouring agents for cleaning.

Dried milk residue is hard to remove. Therefore, always clean immediately after the machine cools down! Always follow the message / instructions in the display on rinsing and cleaning the Spumatore (frother).



Assembled
Spumatore (frother)



Individual parts of the
Spumatore (frother)

NOTE

From time to time (ideally before every longer break in coffee making, but always on a regular basis!), the Spumatore (frother) must be disassembled completely and then cleaned under clean water.

i NOTE

You can continue to draw beverages. But we recommend changing the filter immediately.

! CAUTION

Insert the filter **straight** and do not overturn.



Unscrew / screw
in the filter
(in the water tank)

! CAUTION

In case of low water consumption, you must replace the filter not later than after two months. No message appears in the display. You can set the replacement date with the dial on the head of the filter (month indicator).

8.9. Change filter

The filter's effectiveness is used up after about 50 l of water has flowed through it. A message / instruction to replace the filter appears in the display.

- In the **SETTINGS** menu, select the **FILTER** menu option
- Select **REPLACE FILTER**
- Empty the water tank; carefully unscrew the old filter from its holder using the mounting aid at the end of the measuring spoon, and throw the filter away
- Carefully screw the new filter into its intended holder in the water tank using the mounting aid at the end of the measuring spoon
- Follow the instructions in the display up to the end of the program and confirm each time with the *rotary dial*
- Wait for some time until no more water comes out of the outlet

The machine then heats up and is ready for operation again.

8.10. Status of maintenance

The machine shows through a progress bar whether cleaning or descaling will be required soon. The further to the right the progress bar is, the sooner the cleaning / descaling will be needed

- In the **MAINTENANCE** menu, select the **STATUS OF MAINTENANCE** menu option

9. SOLVING PROBLEMS YOURSELF

The following table shows some causes and options for solving the problem if the machine does not work properly.

If the system detects a fault, an error message appears in the display:

- **Note error message** (According to the table on page 26/27, error 8 can sometimes resolve itself)
- **Turn off machine**
- **Pull out mains plug**

CAUTION

If an error occurs or a problem cannot be solved by yourself, please contact your specialist retailer or visit the service area at www.nivona.com.

The following information is important for fast, competent processing of the matter

- **Model** of the NIVONA product
- **Serial number**
- If available: **Error number / Error message**

Type plate (example)

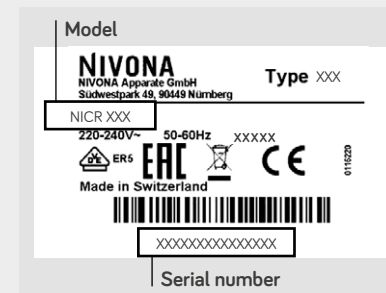

i NOTE

To avoid problems, the following should be observed:

- Always remove the water tank from the machine to fill it
- Do not store coffee beans in the refrigerator
- Always empty containers with the machine switched on
- Use fresh and cooled milk

Problem	Cause	Remedy
No hot water or drawing of milk froth / steam possible	System might need descaling	Perform high-dosage descaling (Chapter 8.5.)
	Spumatore is blocked	Disassemble Spumatore completely and clean it thoroughly
Too little milk froth or liquid froth	Spumatore is blocked	Disassemble Spumatore completely and clean it thoroughly
	Unsuitable milk	Use cold milk
	System might need descaling	Perform high-dosage descaling (Chapter 8.5.)
Coffee comes out only dropwise	System might need descaling	Perform high-dosage descaling (Chapter 8.5.)
	Grind fineness is too fine / too coarse	Set grind fineness coarser / finer (Chapter 7.2.)
	Ground coffee is too fine	Use coarser ground coffee
	Too much ground coffee added	Add less ground coffee
	Brewing unit is plugged	Remove and clean brewing unit (Chapter 8.6.). Reinsert brewing unit and perform a system cleaning (Chapter 8.4.)
	Coffee outlets are plugged	Perform system cleaning (Chapter 8.4.)

Problem	Cause	Remedy
Coffee does not have “foam”	Brewing unit is plugged	Remove and clean brewing unit (Chapter 8.6). Replace brewing unit and perform a system cleaning (Chapter 8.4).
	Unsuitable coffee type	Change coffee type
	Beans are no longer roast-fresh	Use fresh beans
Loud noise in the coffee grinder	Grind fineness not adapted to coffee beans	Optimise grind fineness (Chapter 7.2.)
	Foreign matter in the grinder, e.g. small stones	Call NIVONA service telephone; ground coffee can still be used
The display shows Error 8 Service Tel	The drive cannot properly position the brewing unit	Turn off the machine and pull out the plug. Plug it back in and turn on the machine. If the machine is ready for operation, remove and clean the brewing unit (Chapter 8.6).

DE

GB

FR

NL

PL

RU



EVAPORATE
SYSTEM



CAUTION

The running program must not be interrupted!



WARRANTY AND CUSTOMER SERVICE CONDITIONS

Please see the accompanying information sheet for detailed warranty and customer service conditions.

10.

10. ACCESSORIES & COFFEE ASSORTMENT

Our current assortment of accessories and coffee can be found at www.nivona.com.

11.

11. CUSTOMER SERVICE & WARRANTY

If you have to send in the machine due to a defect, first evaporate it out so that no water remains in the system.

How to make your machine ready for shipment | Evaporate machine

- In the **MAINTENANCE** menu, select the **EVAPORATE SYSTEM** menu option
- Follow the instructions in the display up to the end of the program and confirm each time with the *rotary dial*
- Empty drip pan, coffee grounds container, water tank and the coffee bean holder as well as possible
- Reinsert all parts
- Pack the machine, ideally in the original packaging (no liability can be accepted for transportation damage)

12.

12. PACKAGING & DISPOSAL

The machine's complete original packaging should be kept to protect it during shipping in case customer service is needed.

Electrical and electronic appliances contain many materials which are still valuable or are harmful to the environment, and these should not be treated in the same way as normal household waste. If treated as household waste or handled incorrectly, they may cause harm

to human health or the environment. Therefore, never throw a defective machine away with household waste, but bring it to the municipal collection point for return and recycling of old electrical and electronic devices.

You can obtain more information from your local town hall, waste disposal service provider, or the retailer from whom the machine was purchased.

Filter cartridges are disposed of as household waste.

13. TECHNICAL DATA

Voltage	220 – 240 V AC, 50 – 60 Hz
Power output	1455 W
Conformity mark	CE
Static pump pressure max.	15 bar
Water tank capacity	Approx. 2.2 l
Coffee bean holder capacity	Approx. 250 g
Coffee grounds container capacity	Approx. 7-11 portions*
Cable length	Approx. 1.1 m
Weight	Approx. 9 kg
Dimensions (W x H x D):	Approx. 24 x 34 x 46 cm

* Depending on the amount of beans used





NIVONA

NIVONA Apparate GmbH

Südwestpark 49
D-90449 Nürnberg, Germany
www.nivona.com

2022 © Copyright NIVONA Apparate GmbH, Germany
All rights reserved

ANR 000136439
BDA NICR 5. GB Rev.02 13.07.2022